

# COLLAR

---

LIST  
REGULAR  
B.D  
WIDE  
OTHER



COLLAR

# LIST/COLLAR 1

CO-51



ショートレギュラー

REGULAR 1

CO-00



スタンダードレギュラー

CO-01



レギュラー

REGULAR 2

CO-96



スクエアレギュラー

CO-21



ロングレギュラー

REGULAR 3

CO-71

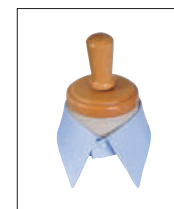

ロングポイント

CO-55



ハイネックショート  
レギュラー

REGULAR 4

CO-52



ショートワイド

WIDE 1

CO-07



スタンダードワイド

CO-11



ワイド

WIDE 2

CO-L11



ワイド  
ロータイプ

CO-31



ドゥエポットーニワイド

WIDE 3

CO-23



セミワイド

WIDE 4

CO-L23



セミワイド  
ロータイプ

CO-25



水平ワイド

WIDE 5

CO-L25



水平ワイド  
ロータイプ

WIDE 5

CO-92



カッタウェイ

WIDE 6

CO-L92



カッタウェイ  
ロータイプ

CO-98



ナボリカッタウェイ

WIDE 7

CO-75



ウインザーワイド

WIDE 8

CO-73



チャールズワイド

CO-54



ショートウインザー

WIDE 9

CO-58



水平  
カッタウェイ

# LIST/COLLAR 2

CO-53



ショートBD

CO-08



スタンダードBD

CO-27



トラディショナルBD

CO-02



ドレスBD

CO-72



ニューイングランドBD

CO-72L



ニューイングランドBD  
ロータイプ

CO-32



ドゥエボットーニBD

CO-22



ロングBD

CO-26



ラウンド

B.D 1

B.D 2

B.D 3

B.D 4

OTHER 1

CO-93



カッタウェイラウンド

CO-79



ラウンドピンホール

CO-74



ラウンドタブカラー  
(ドット/ループ)

CO-76



ラウンドチップ

CO-09



ピンホール

CO-04



タブ(ドット)

CO-04



タブ(ループ)

CO-03



スナップダウン

CO-33



ウイング

CO-97



ナイウイング

OTHER 1

OTHER 2

OTHER 3

OTHER 4

OTHER 5

CO-99



テーラーカラー

CO-05



ワンナップ(ボタン/ループ)

CO-60



ワンピースレギュラー

CO-61



ワンピースBD

CO-62

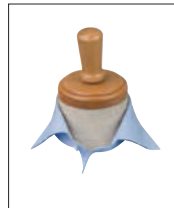

ワンピースワイド

CO-95



ワンピースカッタウェイ

CO-45



イタリアンレギュラー

CO-46



イタリアンBD

CO-47



イタリアンショートレギュラー

CO-48



イタリアンショートBD

OTHER 6

OTHER 7

OTHER 8

OTHER 9

OTHER 10

# LIST/COLLAR 3

---

CO-06



スタンド

CO-34



ドゥエボットーニスタンド

CO-56



ラーシカッタウェイラウンド

CO-57



ナポリラウンド

CO-59



ピンホールカラー

OTHER 11

OTHER 12

OTHER 13

CO-51 [ ショートレギュラー ]

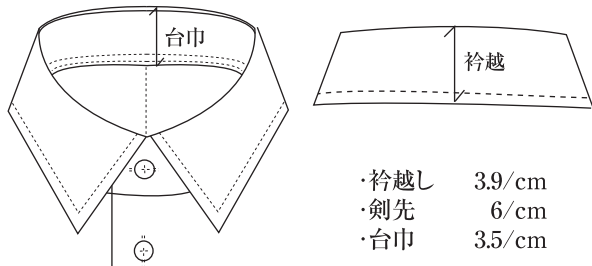

CO-00 [ スタンダードレギュラー ]

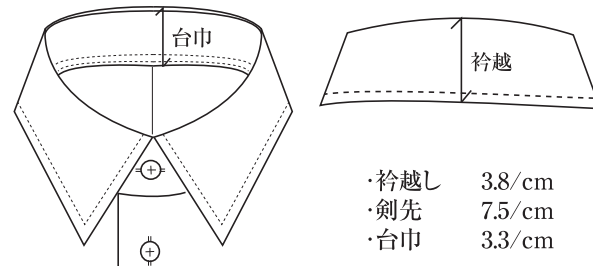

CO-01 [レギュラー]

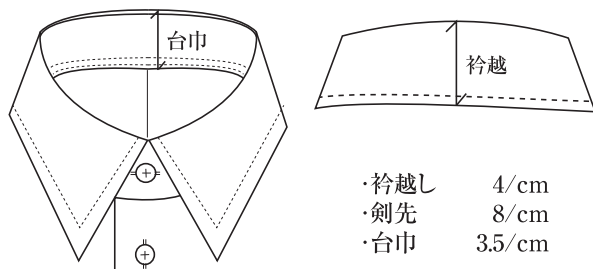

CO-96 [スクエアレギュラー]

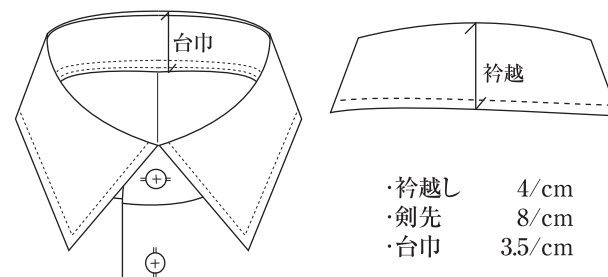

CO-21 [ ロングレギュラー ]

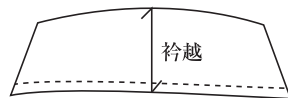
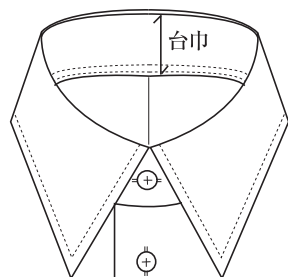

- ・衿越し 4.5/cm
- ・剣先 8.6/cm
- ・台巾 4/cm

CO-71 [ ロングポイント ]

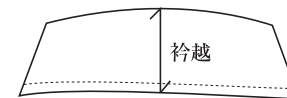
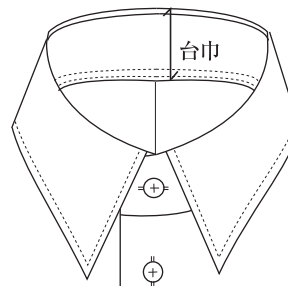

- ・衿越し 4.5/cm
- ・剣先 9/cm
- ・台巾 4/cm



CO-52 [ ショートワイド ]

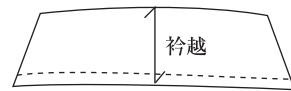
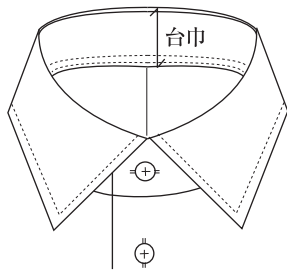

- ・衿越し 3.9/cm
- ・剣先 7.4/cm
- ・台巾 3.5/cm

CO-07 [ スタンダードワイド ]

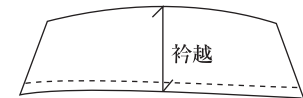
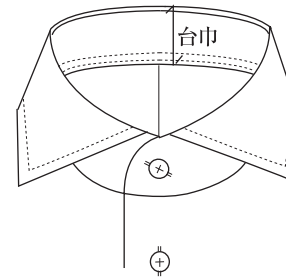

- ・衿越し 3.9/cm
- ・剣先 7.8/cm
- ・台巾 3.5/cm





CO-11 [ワイド]

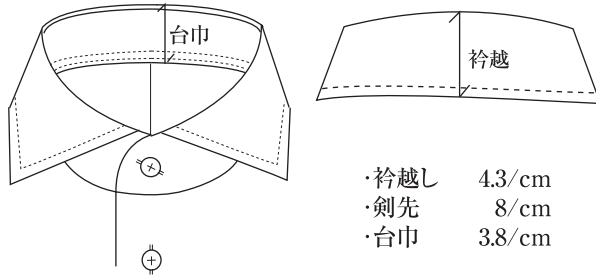

CO-L11 [ワイド]

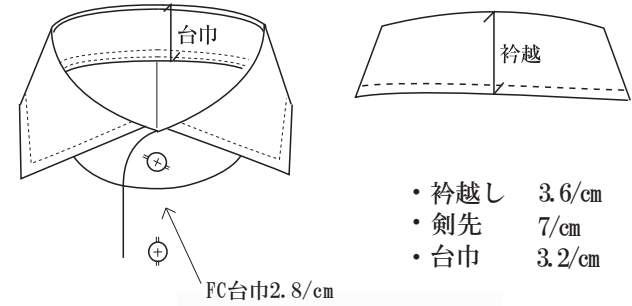

CO-31 [ドゥエボットーニワイド]

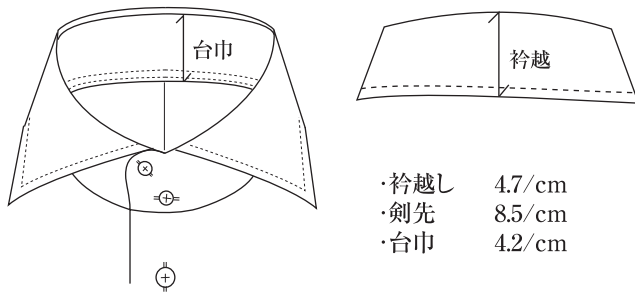

CO-23 [セミワイド]

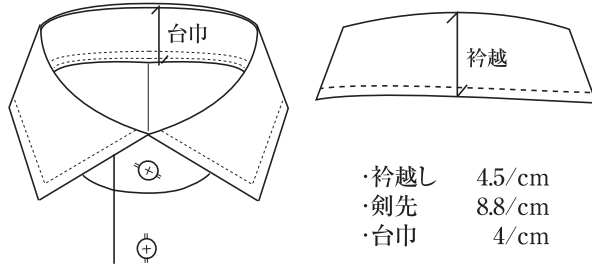

- ・衿越し 4.5/cm
- ・剣先 8.8/cm
- ・台巾 4/cm



CO-L23 [セミワイド]

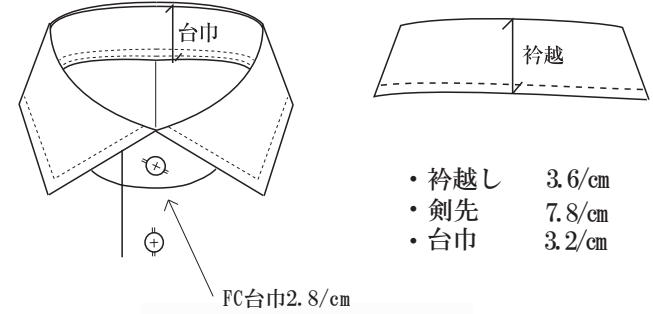

- ・衿越し 3.6/cm
- ・剣先 7.8/cm
- ・台巾 3.2/cm



CO-25 [水平ワイド]

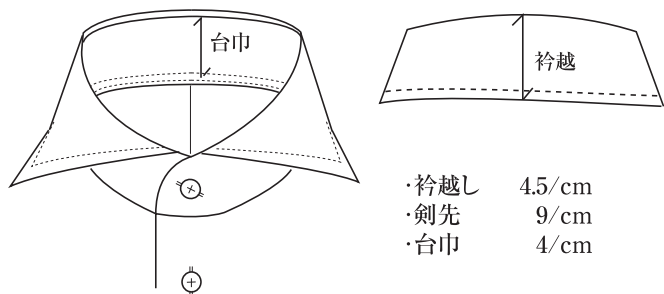

CO-L25 [水平ワイド]

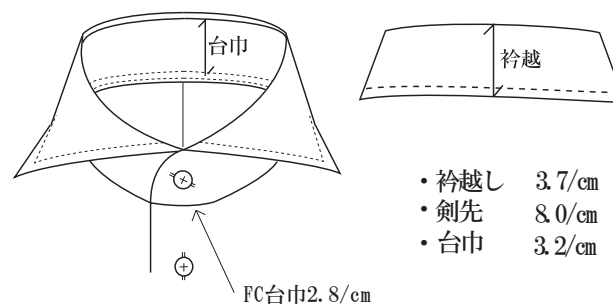

CO-92 [カッタウェイ]

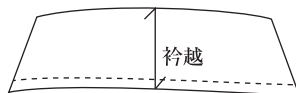
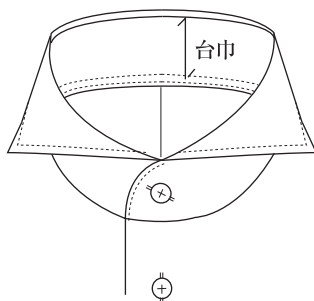

- ・衿越し 4.5/cm
- ・剣先 9/cm
- ・台巾 4/cm

CO-L92 [カッタウェイロータイプ]

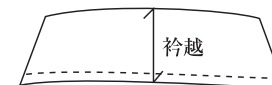
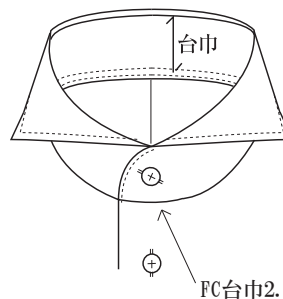

- ・衿越し 3.7/cm
- ・剣先 8.0/cm
- ・台巾 3.2/cm



CO-54 [ショートウィンザー]

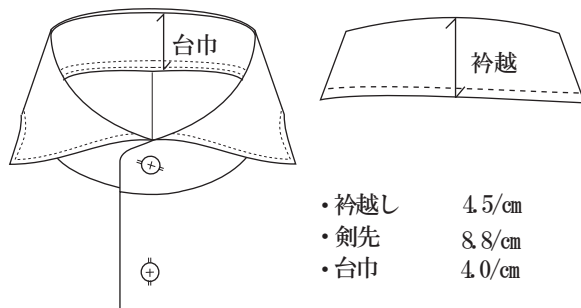

CO-58 [ホリゾンタルカッタウェイ]

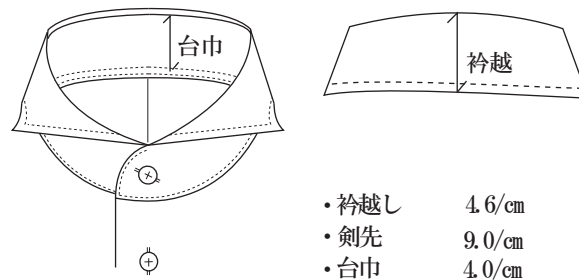

CO-75 [ウインザーワイド]

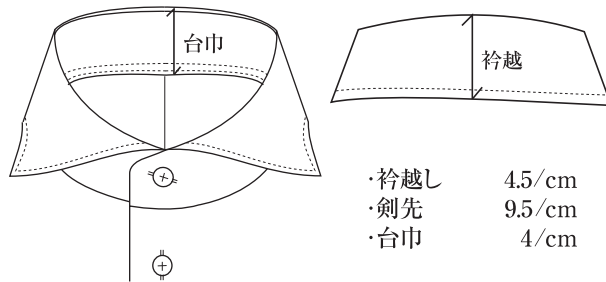

CO-73 [チャールズワイド]

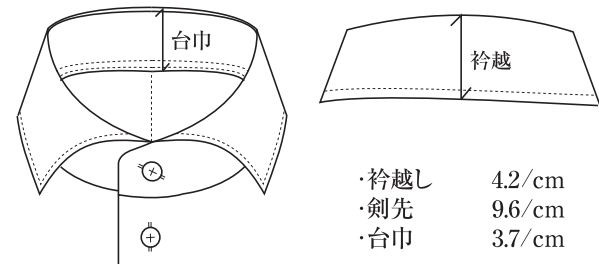

CO-53 [ ショートBD ]

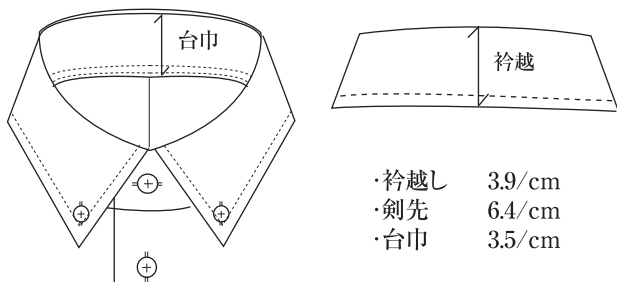

CO-08 [ スタンダードBD ]

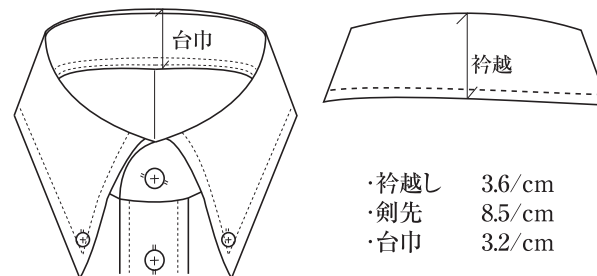



CO-27 [トラディショナルBD]

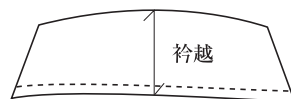
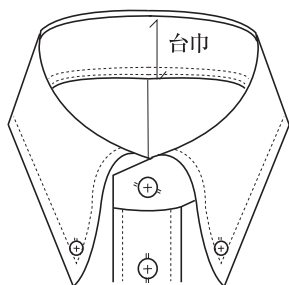

- ・衿越し 4.5/cm
- ・剣先 8.6/cm
- ・台巾 4/cm

CO-02 [ドレスBD]

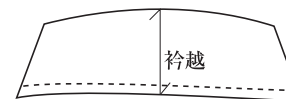
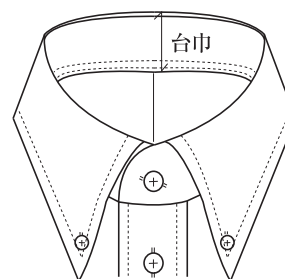

- ・衿越し 4/cm
- ・剣先 9/cm
- ・台巾 3.5/cm



CO-72 [ ニューイングランドBD ]

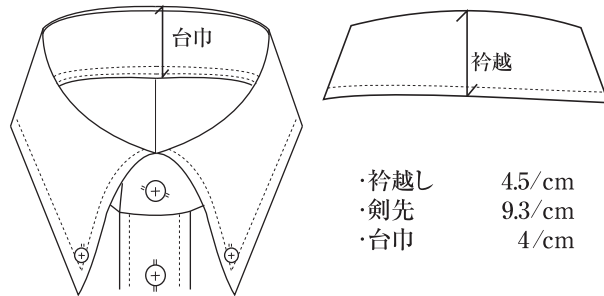

- ・衿越し 4.5/cm
- ・剣先 9.3/cm
- ・台巾 4/cm

CO-L72 [ ニューイングランドBD ]

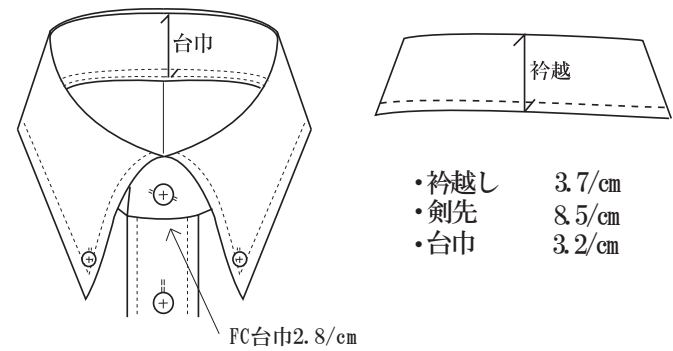

- ・衿越し 3.7/cm
- ・剣先 8.5/cm
- ・台巾 3.2/cm



CO-32 [ドゥエポッターニBD]

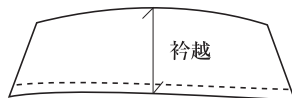
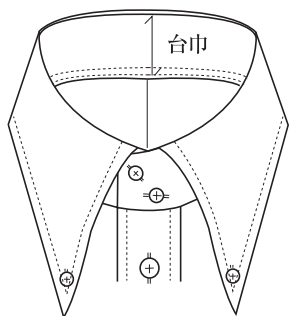

- ・衿越し 4.7/cm
- ・剣先 9.5/cm
- ・台巾 4.2/cm

CO-22 [ロングBD]

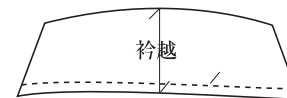
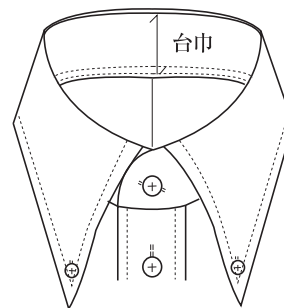

- ・衿越し 4.5/cm
- ・剣先 9.8/cm
- ・台巾 4/cm



CO-26 [ラウンド]

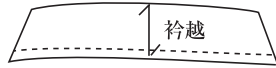
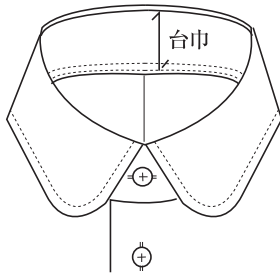

- ・衿越し 4.5/cm
- ・剣先 6.3/cm
- ・台巾 4/cm

CO-93 [カットウェイラウンド]

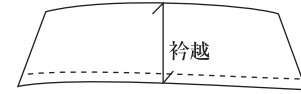
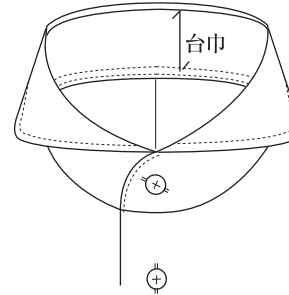

- ・衿越し 4.5/cm
- ・剣先 9.5/cm
- ・台巾 4/cm



CO-79 [ ラウンドピンホール ]

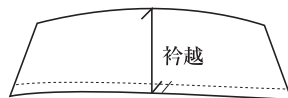
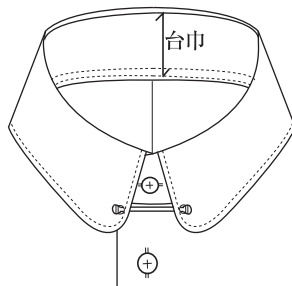

・衿越し 4.3/cm  
・剣先 6.9R/cm  
・台巾 3.8/cm

CO-74 [ ラウンドタブカラー ]

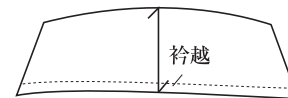
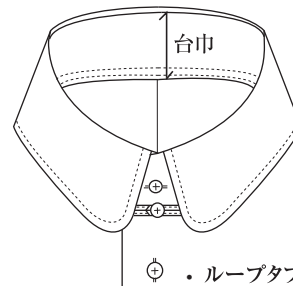

・衿越し 4.3/cm  
・剣先 6.9R/cm  
・台巾 3.8/cm

⊕ ・ループタブ  
・ドットタブ



CO-76 [ラウンドチップ]

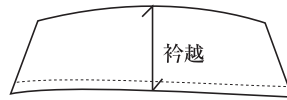
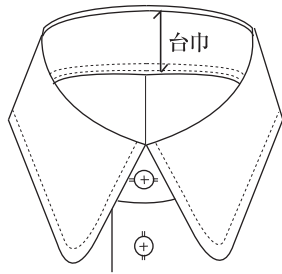

- ・衿越し 4.5/cm
- ・剣先 8.0/cm
- ・台巾 4.0/cm

CO-09 [ピンホール]

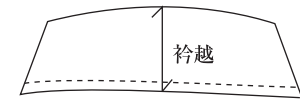
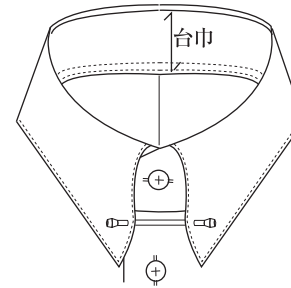

- ・衿越し 4.2/cm
- ・剣先 8.5/cm
- ・台巾 3.8/cm



CO-04 [ タブ(ドット/ループ) ]

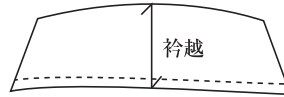
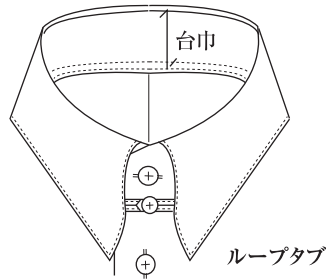

- ・衿越し 4/cm
- ・剣先 8.6/cm
- ・台巾 3.5/cm

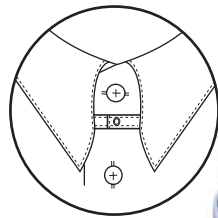

ドットタブ



CO-03 [ スナップダウン ]

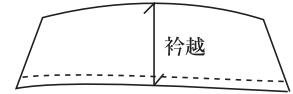
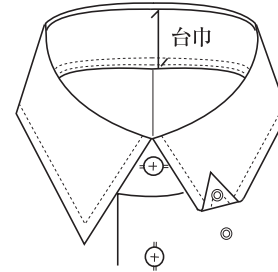

- ・衿越し 4/cm
- ・剣先 9/cm
- ・台巾 3.5/cm



CO-33 [ウイング]

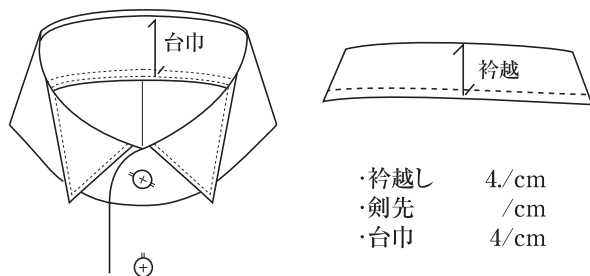

- ・衿越し 4/cm
- ・剣先 /cm
- ・台巾 4/cm

CO-97 [ナイトウイング]

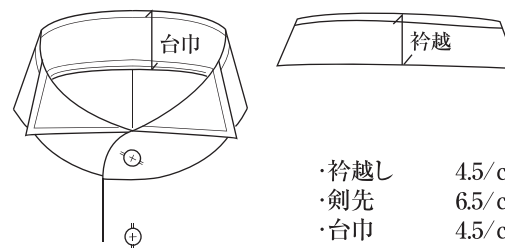

- ・衿越し 4.5/cm
- ・剣先 6.5/cm
- ・台巾 4.5/cm





CO-99 [テーラーカラー]

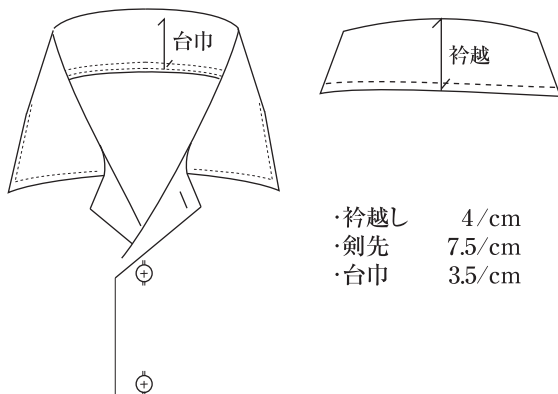

\*CO-99 OPEN BODY専用  
ボタンナップのみ

CO-05 [ワンナップ]

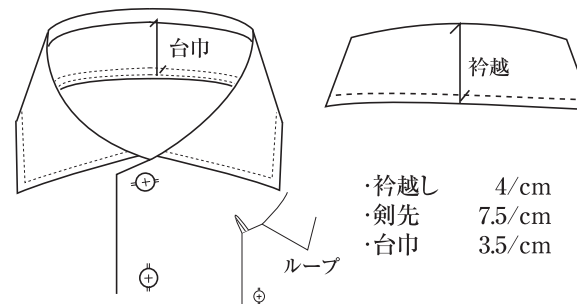

CO-60 [ワンピースレギュラー]

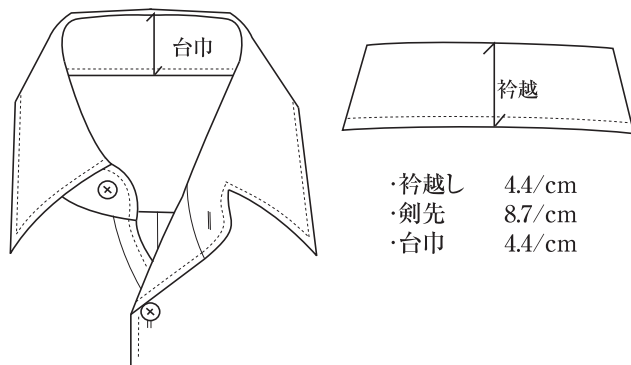

CO-61 [ワンピースBD]

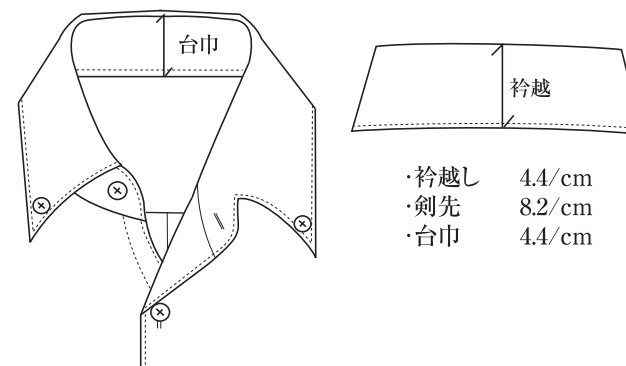

※ワンピースカラーはルミラーステータンなしとなります。

CO-62 [ワンピースワイド]

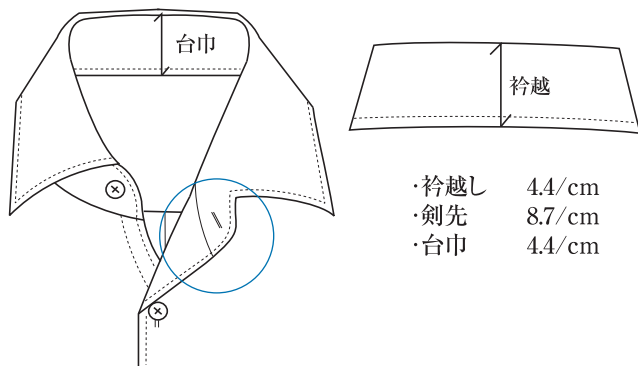

CO-95 [カッタウェイワンピース]

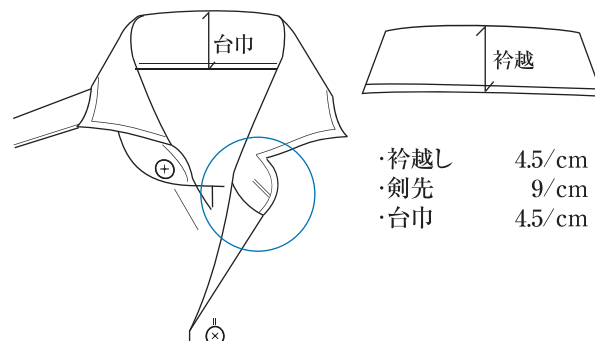

※ワンピースカラーはルミラーステー無しとなります。

CO-45 [ イタリアンレギュラー ]

OP

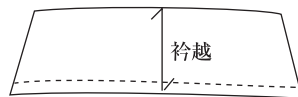
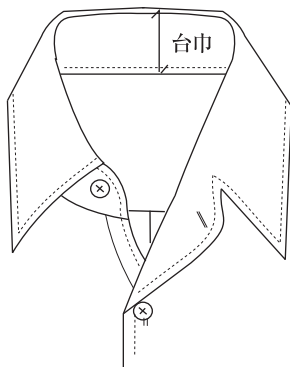

- ・衿越し 4/cm
- ・剣先 9/cm
- ・台巾 4/cm



CO-46 [ イタリアンBD ]

OP

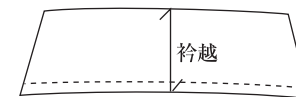
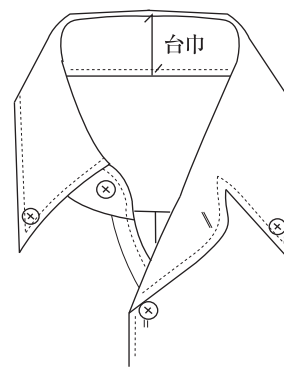

- ・衿越し 4/cm
- ・剣先 9/cm
- ・台巾 4/cm



CO-47 [ イタリアンショートレギュラー ]

OP

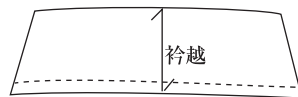
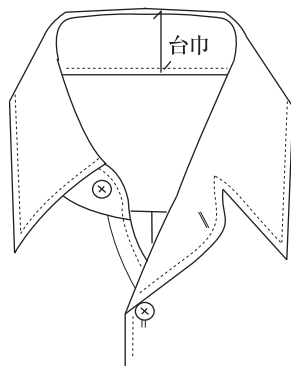

- ・衿越し 3.8/cm
- ・剣先 7/cm
- ・台巾 3.8/cm



CO-48 [ イタリアンショートBD ]

OP

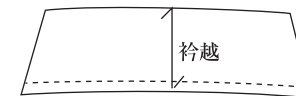
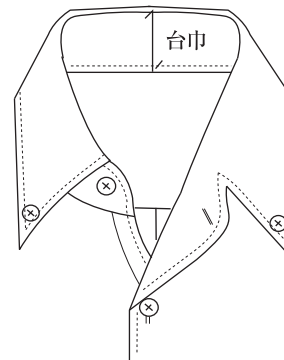

- ・衿越し 3.8/cm
- ・剣先 7/cm
- ・台巾 3.8/cm



CO-06 [ スタンド ]

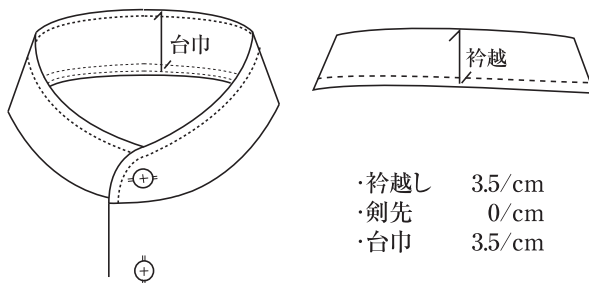

- ・衿越し 3.5/cm
- ・剣先 0/cm
- ・台巾 3.5/cm

CO-34 [ ドゥエボットーニスタンド ]

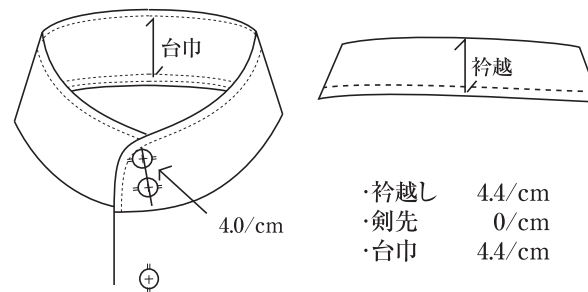

- ・衿越し 4.4/cm
- ・剣先 0/cm
- ・台巾 4.4/cm



CO-56 [ ラージラウンドカッタウェイ ]

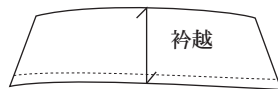
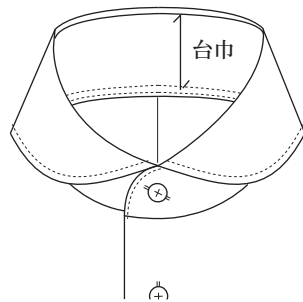

- ・衿越し 4.5/cm
- ・剣先 8.7R/cm
- ・台巾 4.0/cm
- ・ルミラースティ無し



CO-57 [ ナポリラウンド ]

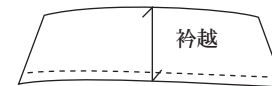
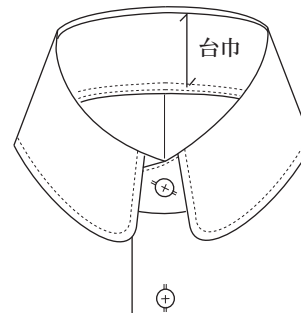

- ・衿越し 4.5/cm
- ・剣先 7.4R/cm
- ・台巾 4.0/cm



CO-59 [ ワイドピンホール ]

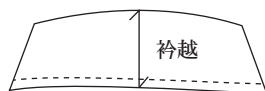
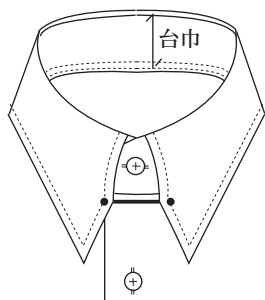

- ・衿越し 4.5/cm
- ・剣先 9.8/cm
- ・台巾 4.0/cm





# OFFBEAT/COLLAR

CO-86 OP



ドゥエポットーニ二枚衿/BD

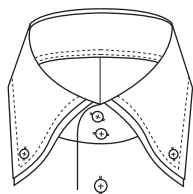

・衿越し 4.7/cm (5.2/5.8/cm)  
 ・剣先 下羽9.4/上羽9.7cm  
 ・台巾 4.2/cm

CO-87 OP



ドゥエポットーニ二枚衿/BD

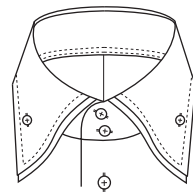

・衿越し 4.7/cm (5.2/5.8/cm)  
 ・剣先 下羽9.4/上羽9.7cm  
 ・台巾 4.2/cm

CO-88 OP



ドゥエポットーニ二枚衿/BD

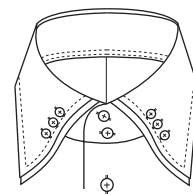

(5.2/cm)  
 ・衿越し 4.7/cm (5.8/cm)  
 ・剣先 下羽9.4/上羽9.7cm  
 ・台巾 4.2/cm

CO-89 OP



ドゥエポットーニ二枚衿/WIDE

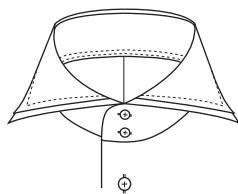

・衿越し 4.7/cm  
 ・剣先 9.0/cm  
 ・台巾 4.2/cm

CO-90 OP



トレポットーニ・2枚衿/BD

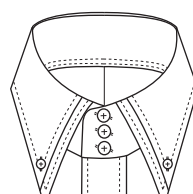

・衿越し 5.5/cm (6.0/cm)  
 ・剣先 10.0/cm  
 ・台巾 5.0/cm

CO-91 OP



イタリアン・スタンドカラー

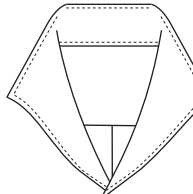

・衿越し 4.6/cm  
 ・剣先 5.2/cm  
 ・台巾 4.6/cm

<衿型スペック>

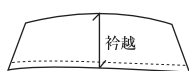
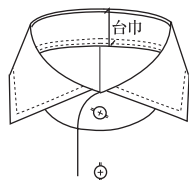

# OFFBEAT/COLLAR

CO-80



トレポッターニスナップダウン

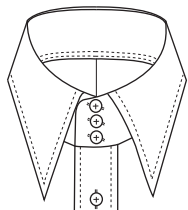

- ・衿越し 5.5/cm (6.0/cm)
- ・剣先 10.0/cm
- ・台巾 5.0/cm

CO-81



トレポッターニ/BD-1

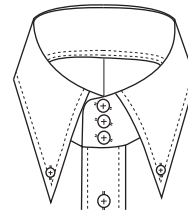

- ・衿越し 5.5/cm (6.0/cm)
- ・剣先 10.0/cm
- ・台巾 5.0/cm

CO-82



トレポッターニ/BD-2

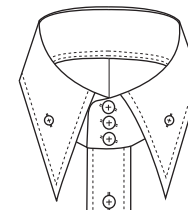

- ・衿越し 5.5/cm (6.0/cm)
- ・剣先 10.0/cm
- ・台巾 5.0/cm

CO-83



トレポッターニWIDE

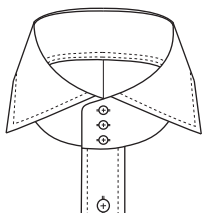

- ・衿越し 5.5/cm (6.0/cm)
- ・剣先 9.6/cm
- ・台巾 5.0/cm

CO-84



トレポッターニWIDE

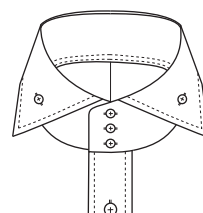

- ・衿越し 5.5/cm (6.0/cm)
- ・剣先 9.6/cm
- ・台巾 5.0/cm

CO-85

OP



ドゥエポッターニ二枚衿/REG

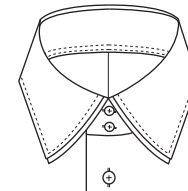

- ・衿越し 4.7/cm
- ・剣先 9.0/cm
- ・台巾 4.2/cm

<衿型スペック>

